

**Bohrbild
für 2-Wege Ventil (UN 1 5/8")
C-20-2**



Symbol:

C-20-2



IMAV-Hydraulik GmbH
Breite Strasse 10
D-40670 Meerbusch (Osterath)
Telefon +49 (0)2159 - 9188.0
Telefax +49 (0)2159 - 4242
E-mail: info@imav.com
Internet: <http://www.imav.com>

IK-100-209-00
(Änderungen vorbehalten!)

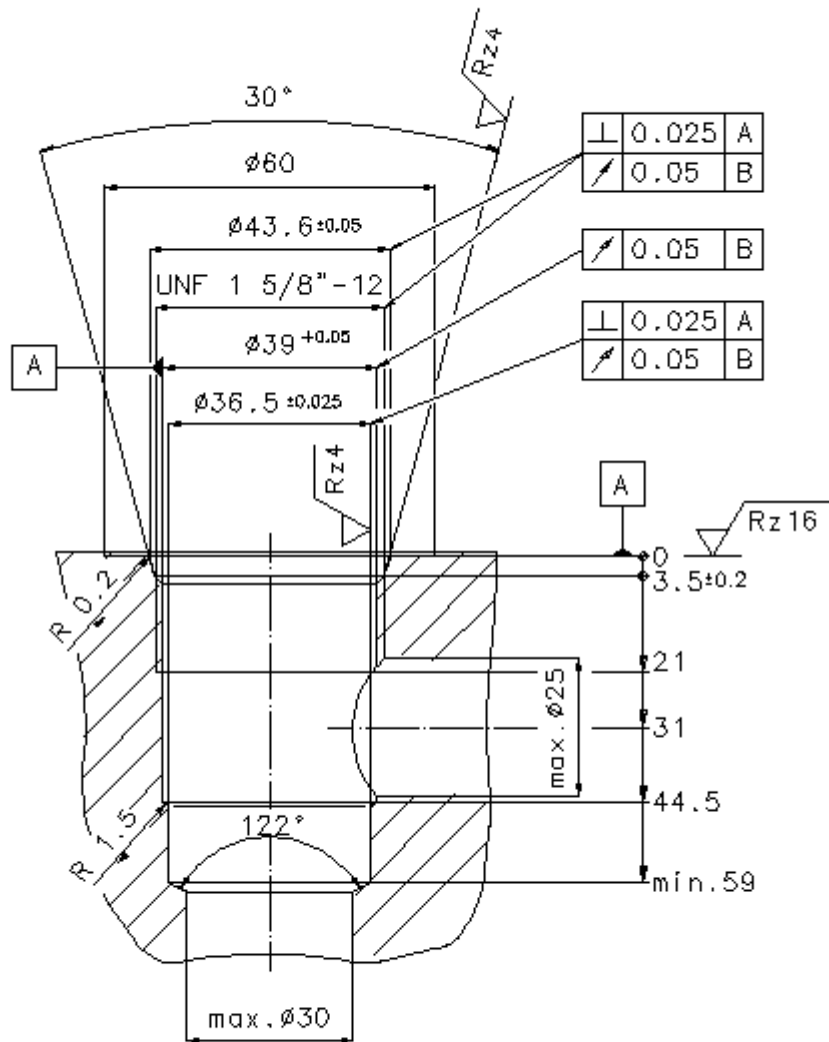

**Bohrbild
für 2-Wege Ventil (UN 1 5/8")
C-20-2**



IMAV-Hydraulik GmbH
Breite Strasse 10
D-40670 Meerbusch (Osterath)
Telefon +49 (0)2159 - 9188.0
Telefax +49 (0)2159 - 4242
E-mail: info@imav.com
Internet: <http://www.imav.com>

IK-100-209-00
(Änderungen vorbehalten!)