

cavity
for 3-way valve (UNF 7/8")
C-10-3



Symbol:

C-10-3



IMAV-Hydraulik GmbH
 Breite Strasse 10
 D-40670 Meerbusch (Osterath)
 Phone +49 (0)2159 - 9188.0
 Fax +49 (0)2159 - 4242
 E-mail: info@imav.com
 Internet: <http://www.imav.com>

IK-300-109-00

(Subject to change!)

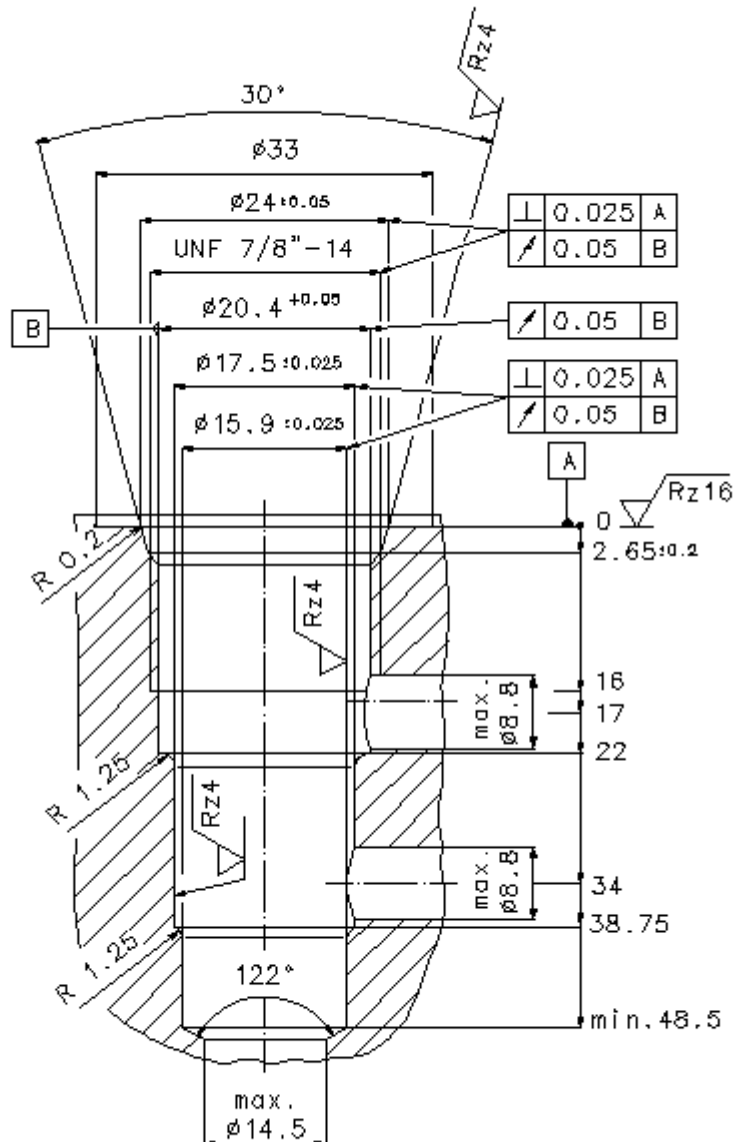

cavity
for 3-way valve (UNF 7/8")
C-10-3



IMAV-Hydraulik GmbH
Breite Strasse 10
D-40670 Meerbusch (Osterath)
Phone +49 (0)2159 - 9188.0
Fax +49 (0)2159 - 4242
E-mail: info@imav.com
Internet: <http://www.imav.com>

IK-300-109-00

(Subject to change!)