

**linking/crossover plate CETOP 3
P with A conn., T with B connected
UP-06.-PA+TB**

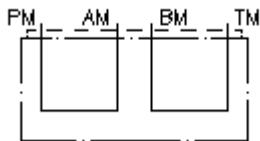

Symbol:

Nom. pressure:
350 bar



IMAV-Hydraulik GmbH
Breite Strasse 10
D-40670 Meerbusch (Osterath)
Phone +49 (0)2159 - 9188.0
Fax +49 (0)2159 - 4242
E-mail: info@imav.com
Internet: <http://www.imav.com>

IZ-850-205-00

(Subject to change!)

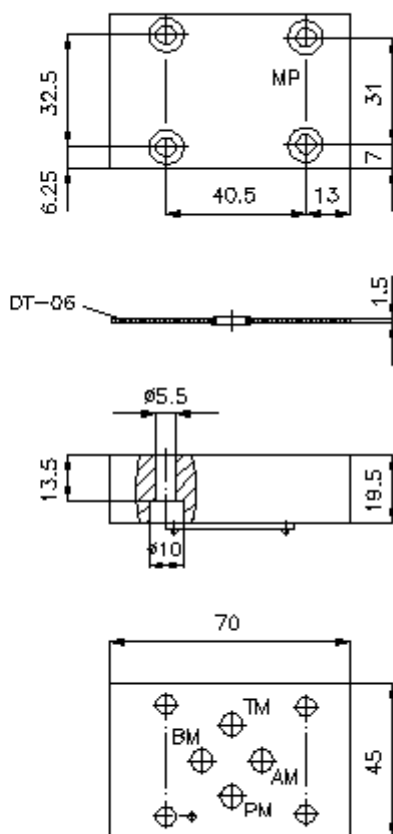

**linking/crossover plate CETOP 3
P with A conn., T with B connected
UP-06.-PA+TB**



IMAV-Hydraulik GmbH
Breite Strasse 10
D-40670 Meerbusch (Osterath)
Phone +49 (0)2159 - 9188.0
Fax +49 (0)2159 - 4242
E-mail: info@imav.com
Internet: <http://www.imav.com>

IZ-850-205-00
(Subject to change!)

Ordering example:

UP - 06A - PA+TB
| | |
A **B** **C**

Model code:

- A design**
turn round plate
with mounting interface DIN 24340 form A
- B size and material**
06A = aluminum (F37)
06S = steel (9SMnPb28K resp. GGG-40)
- C function mode**
PA+TB = P with A and T with B connected

Technical Data:

- note:** required mounting screws:
4 pcs. M5 x 25 DIN 912
- nominal pressure:** 250 bar (A)
350 bar (S)
- weight:** 0.2 / 0.5 kg (A/S)
- included:** DT-06 = sealing plate with vulcanized O-ring (Viton FPM)